

TOOTMINE.

Viking Window AS
Mõo, Järvamaa 72751 tlf.372 38 48 900

VIKING SW11 WINDOW CROSS SECTION OF SILL

JOONISE NR:

SW2.00.01

KUUPÄEV: 23.05.11 VJ.

MÕÖT: 1:1

REVISION A: 14.09.11 VJ.

REVISION B:

KINNITATUD:

REVISION C:

RN.

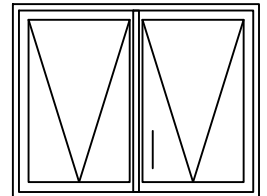
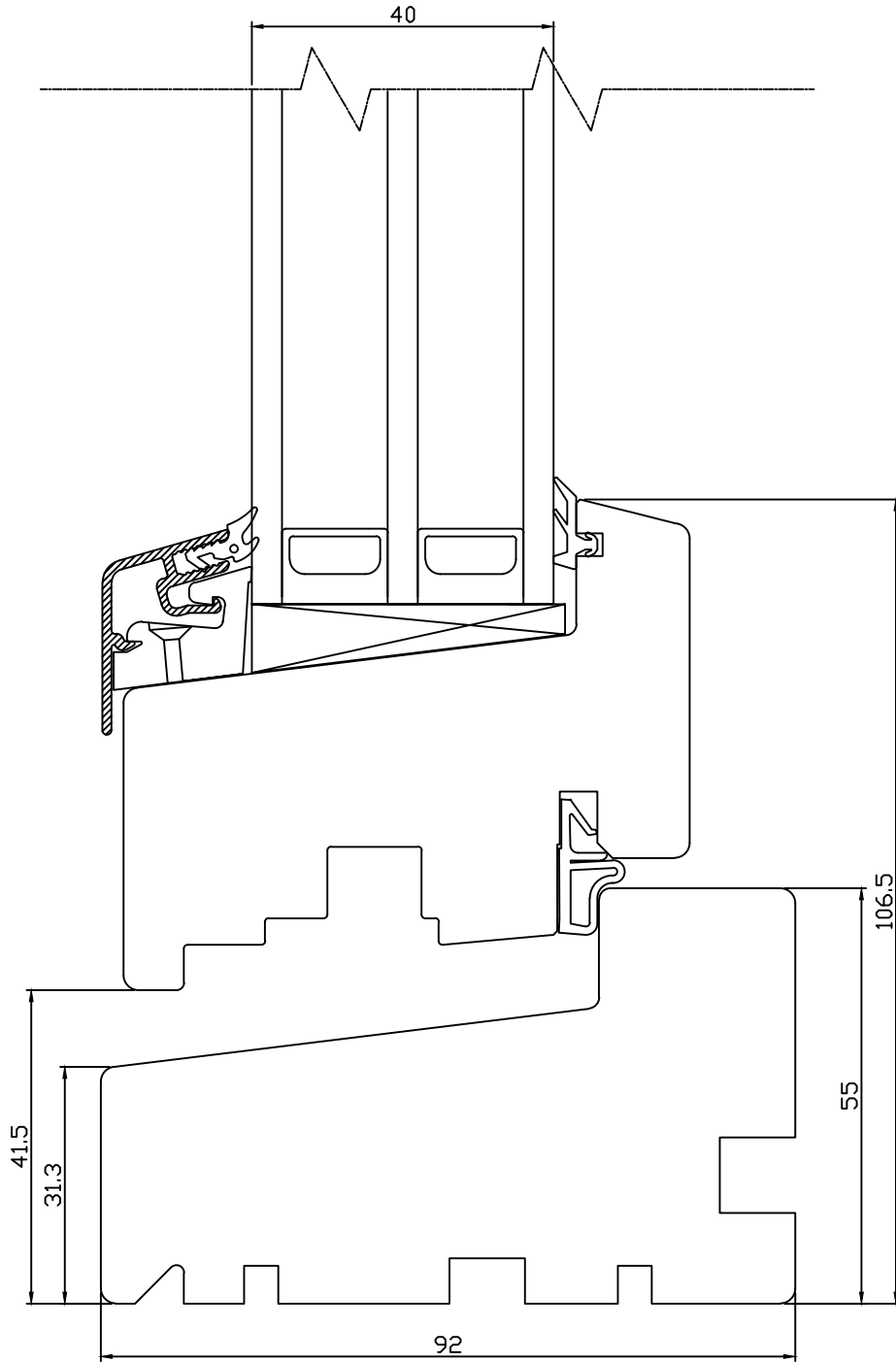

Tootja jätab endale õiguse teha muudatusi !

TOOTMINE.

Viking Window AS
Mõo, Järvamaa 72751 tlf.372 38 48 900

VIKING SW11 WINDOW CROSS SECTION OF JAMB

JOONISE NR:
SW2.00.03

KUUPÄEV: 23.05.11 VJ.

MÕÖT: 1:1

REVISION A: 14.09.11 VJ.

REVISION B:

KINNITATUD:

REVISION C:

RN.

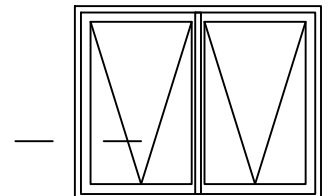
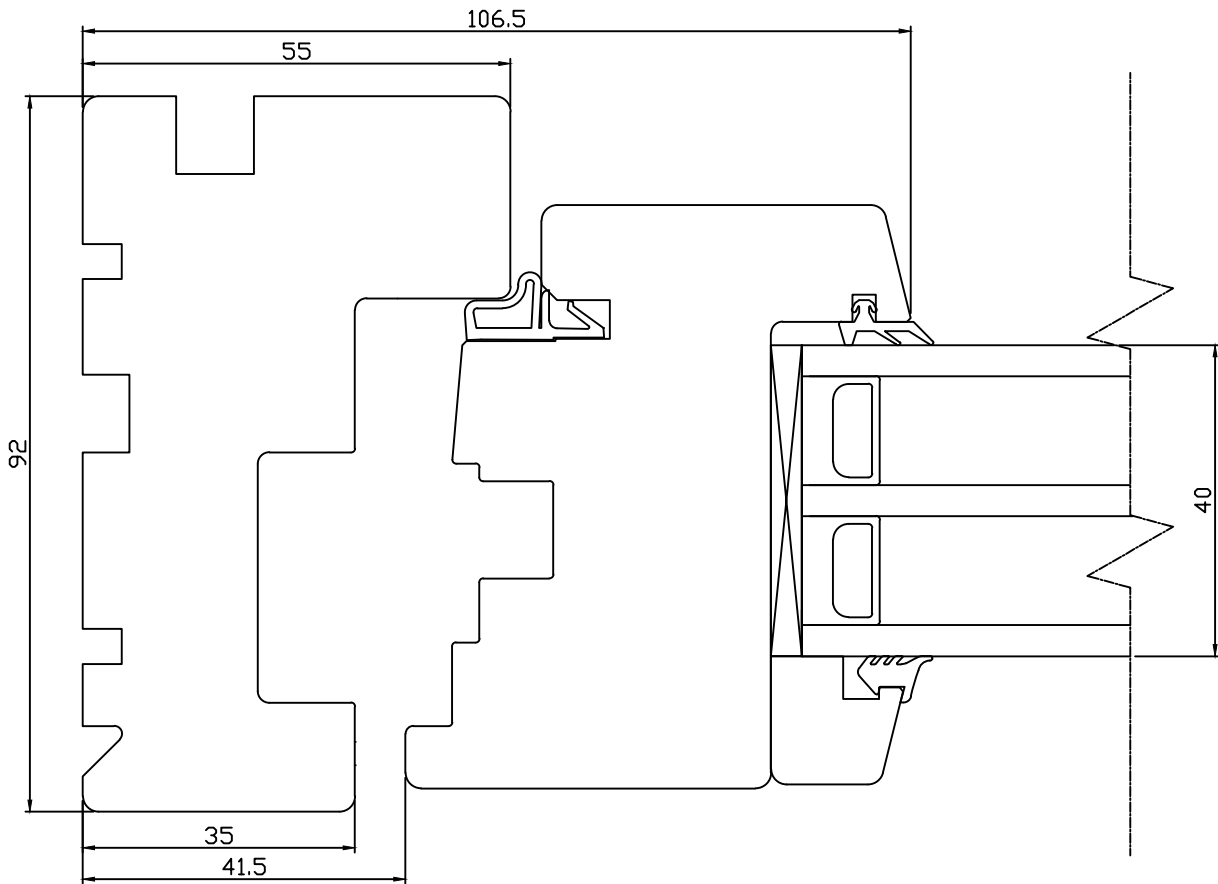

TOOTMINE.

Viking Window AS
Mäo, Järvamaa 72751 tlf.372 38 48 900

VIKING SW11 WINDOW CROSS SECTION OF HEAD

JOONISE NR:
SW2.00.05

KUUPÄEV: 23.05.11 VJ.

MÕÖT: 1:1

REVISION A: 14.09.11 VJ.

REVISION B:

KINNITATUD:

REVISION C:

RN.

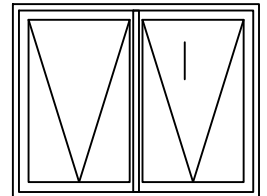
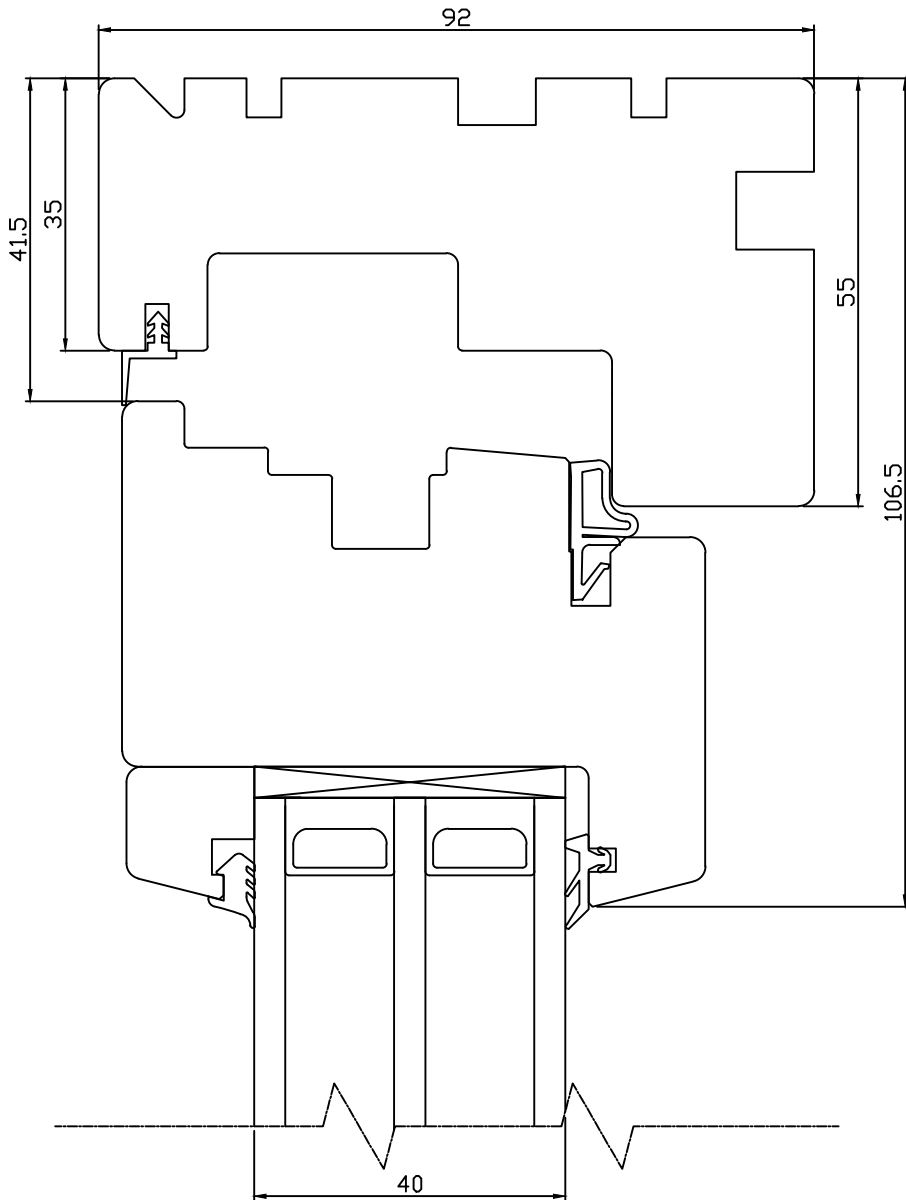

TOOTMINE.

Viking Window AS
Mõo, Järvamaa 72751 tlf.372 38 48 900

VIKING SW11 WINDOW CROSS SECTION OF TRANSOM

JOONISE NR:
SW2.00.07

KUUPÄEV:	23.05.11	VJ.
REVISION A:	14.09.11	VJ.
REVISION B:		
REVISION C:		

MÕÖT:	1:1
KINNITATUD:	
RN.	

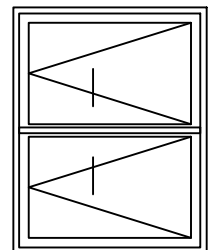
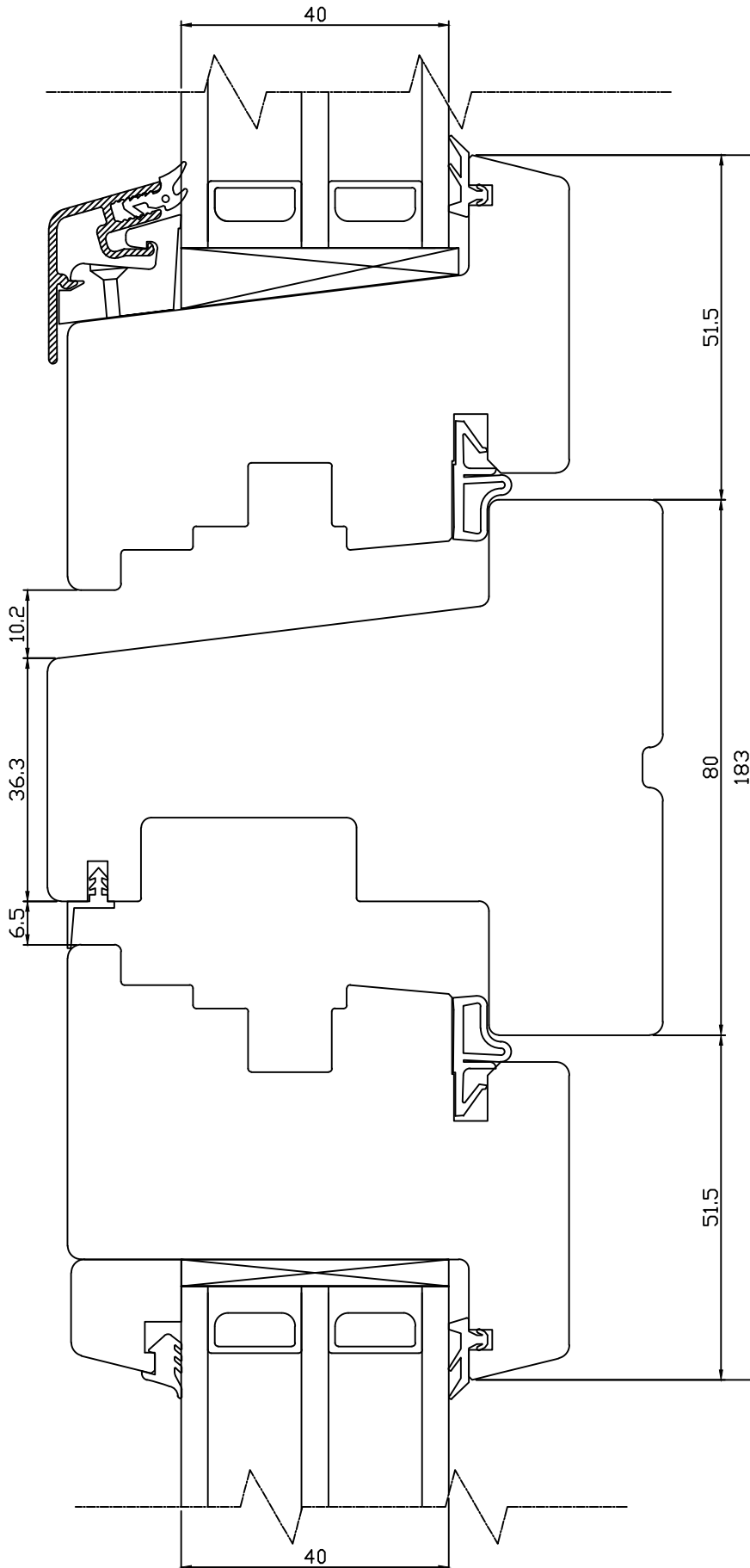

Tootja jätab endale õiguse teha muudatusi !

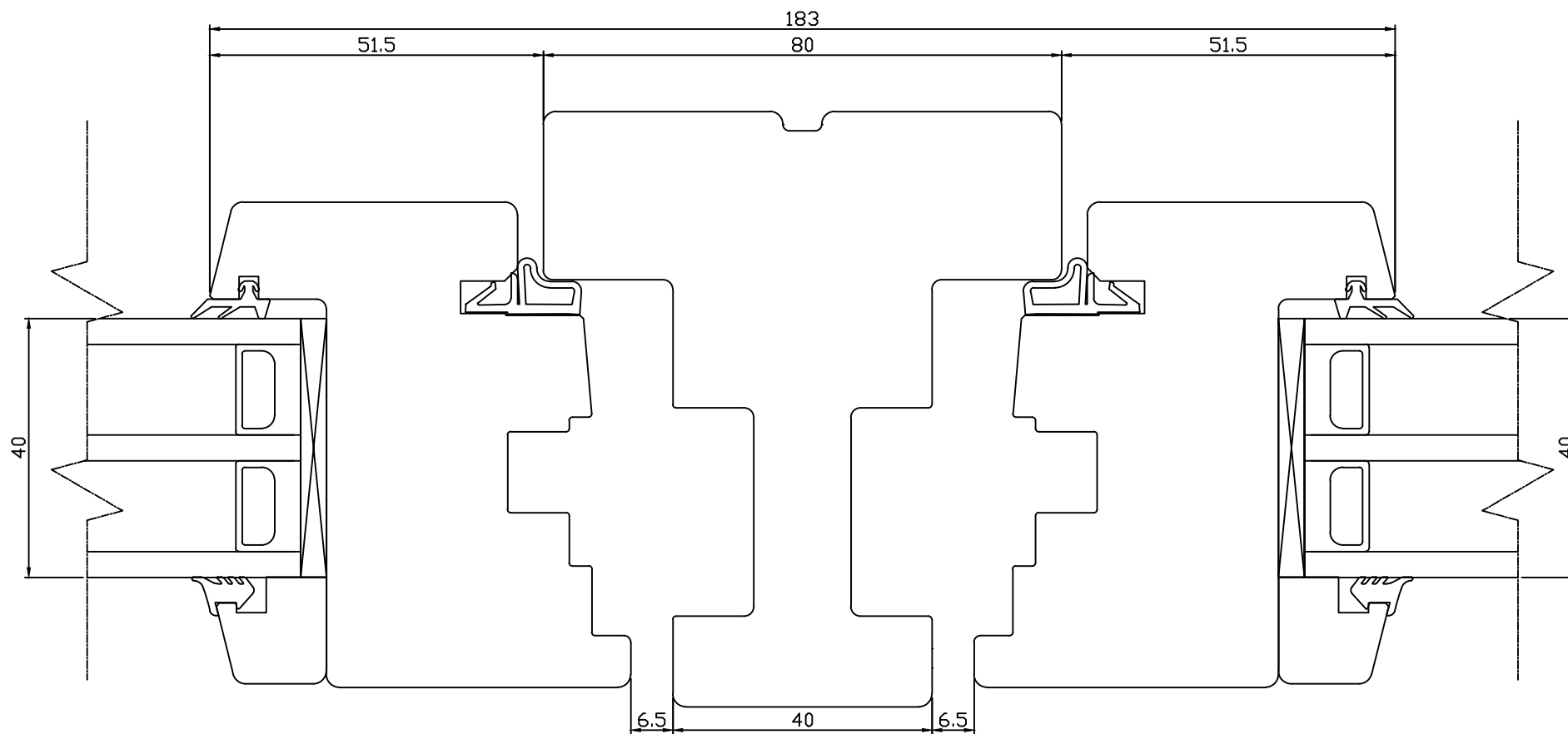

Tootja jätab endale õiguse teha muudatusi !

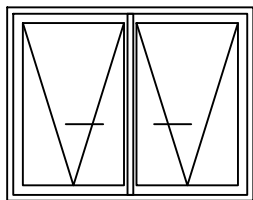

TOOTMINE.		VIKING SW11 WINDOW CROSS SECTION OF MULLION		JOOINISE NR: SW2.00.09
Viking Window AS Mõo, Järvamaa 72751 tlf.372 38 48 900				MÕÖT: 1:1
KUUPÄEV: 23.05.11 REVISION A: 14.09.11 REVISION B: REVISION C:	VJ. VJ.			KINNITATUD: RN.

TOOTMINE.

Viking Window AS
 Mäo, Järvamaa 72751 tlf.372 38 48 900

VIKING SW11 WINDOW

CROSS SECTION OF REBATED DOUBLE CASEMENT

JOONISE NR:

SW2.00.11

KUUPÄEV:	23.05.11	VJ.
REVISION A:	21.09.11	VJ.
REVISION B:	28.09.11	VJ.
REVISION C:		

MÖÖT:	1:1
KINNITATUD:	
RN.	

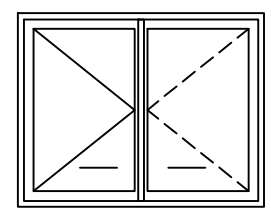
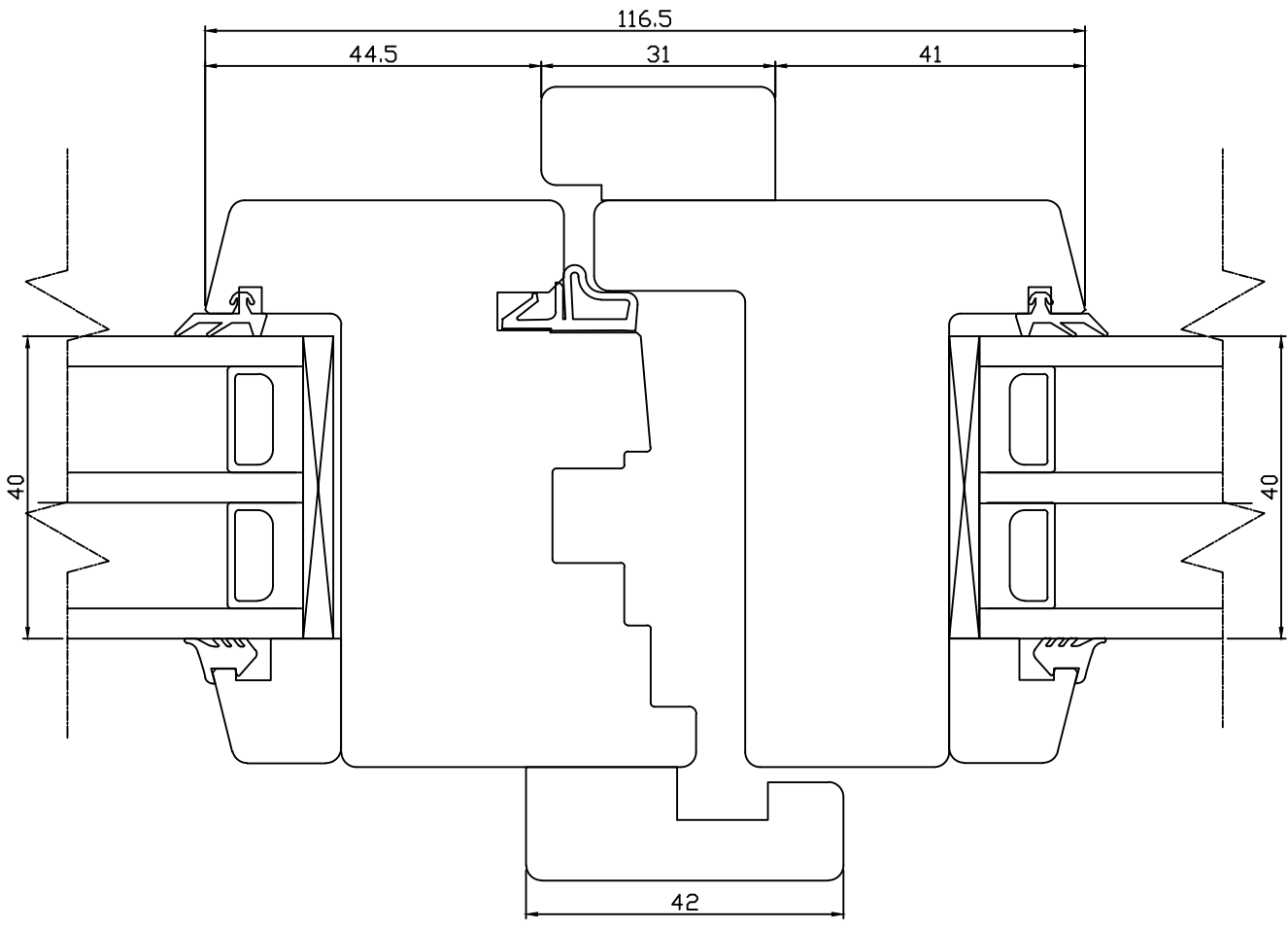

TOOTMINE.

Viking Window AS
Mõo, Järvamaa 72751 tlf.372 38 48 900

VIKING SW11 WINDOW

CROSS SECTION OF 56 mm GLAZING BARS

JOONISE NR:

SW2.00.12

KUUPÄEV: 23.05.11 VJ.

MÕÖT: 1:1

REVISION A:

REVISION B:

REVISION C:

KINNITATUD:

RN.

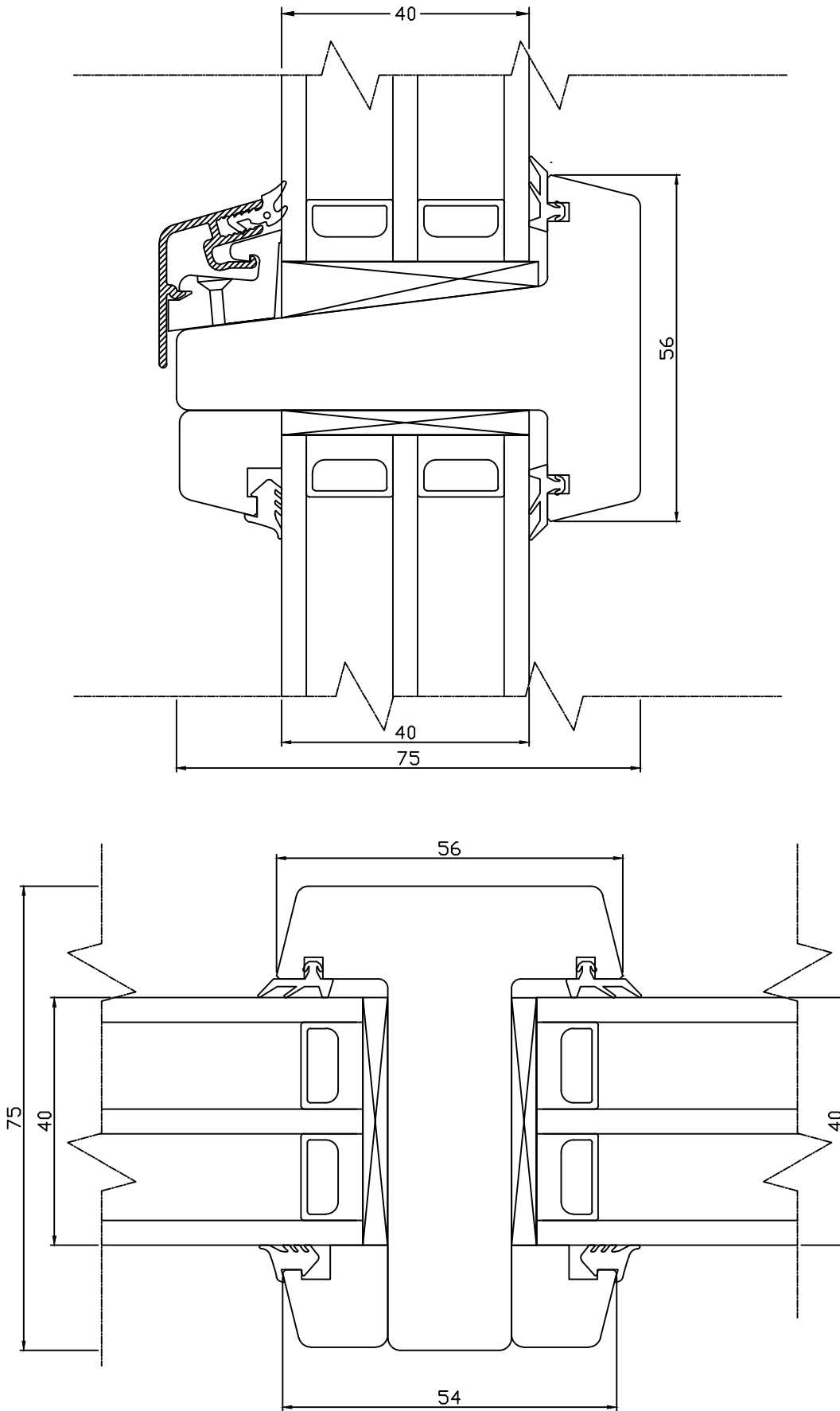

Tootja jätab endale õiguse teha muudatusi !